

# Electronic Copy

CI/SfB



## Quad-Lock Building Systems

7398 — 132nd Street  
Surrey  
British Columbia V3W 4M7  
Canada

Tel: 0870 443 1901 Fax: 0870 443 1902  
e-mail: info@quadlock.co.uk  
website: www.quadlock.co.uk

|      |   |     |
|------|---|-----|
| (21) | R | (M) |
|------|---|-----|

**Agreement  
Certificate  
No 06/4347**

Designated by Government  
to issue  
European Technical  
Approvals

## QUAD-LOCK INSULATING CONCRETE FORMWORK (ICF) SYSTEM

Coffrage perdu  
Betonschalung permanent

# Product



• THIS CERTIFICATE RELATES TO THE QUAD-LOCK INSULATING CONCRETE FORMWORK (ICF) SYSTEM, COMPRISING EXPANDED POLYSTYRENE PANELS WITH HIGH-DENSITY POLYETHYLENE INTERCONNECTING SPACERS.

- The system is for use in loadbearing and non-loadbearing internal or external and separating walls in dwellings and in buildings of similar occupancy.
- The system provides permanent formwork for in-situ dense aggregate concrete walls and contributes to the thermal insulation of the finished construction.
- It is for use with suitable internal and external finishes.

continued

## Regulations

### 1 The Building Regulations 2000 (as amended) (England and Wales)

The Secretary of State has agreed with the British Board of Agrément the requirements of the Building Regulations to which formwork can contribute in achieving compliance. In the opinion of the BBA, the Quad-Lock Insulating Concrete Formwork (ICF) System, if used in accordance with the provisions of this Certificate, will meet or contribute to meeting the relevant requirements.

|                          |   |
|--------------------------|---|
| Requirement: A1          | Loading   |
| Requirement: A2          | Ground movement   |
| Requirement: A3          | Disproportionate collapse   |
| Comment:                 | Walls will have adequate strength and stiffness to satisfy these Requirements. See sections 7.2, 7.3, 9.1 and 9.2 of this Certificate.  |
| Requirement: B3(1)(2)(3) | Internal fire spread (structure)  |
| Comment:                 | Walls can meet this Requirement. See sections 16.1 to 16.5 of this Certificate.   |
| Requirement: C2(a)       | Resistance to moisture  |
| Comment:                 | Walls can adequately limit the risk of moisture ingress from the ground. See sections 7.2, 7.3 and 15.1 of this Certificate.  |
| Requirement: C2(c)       | Resistance to moisture  |
| Comment:                 | Walls can adequately limit the risk of surface condensation and contribute to minimising the risk of interstitial condensation. See sections 12.1 and 12.2 of this Certificate. |
| Requirement: E1          | Protection against sound from other parts of the building and adjoining buildings   |
| Requirement: E2          | Protection against sound within a dwelling-house etc  |
| Comment:                 | Walls can adequately meet these Requirements. See sections 13.1 to 13.3 of this Certificate.  |

continued

- Subject to design and supervision by a chartered engineer, the formwork may be used for constructing basement, retaining and shear walls.

# Electronic Copy

|              |               |  |
|--------------|---------------|--|
| Requirement: | L1(a)(i), (b) | Conservation of fuel and power   |
| Comment:     |               | Walls can contribute to meeting the Target Emission Rate. See section 10.2 of this Certificate. Walls can also adequately limit heat loss by unwanted air infiltration and excessive additional heat loss at junctions between walls, with other elements and around openings. See sections 10.1 to 10.4, 11.1 and 11.2 of this Certificate. |
| Requirement: | Regulation 7  | Materials and workmanship  |
| Comment:     |               | The system is acceptable. See sections 19.1 and 19.2 of this Certificate.  |

## 2 The Building (Scotland) Regulations 2004



In the opinion of the BBA, the Quad-Lock Insulating Concrete Formwork (ICF) System, if used in accordance with the provisions of this Certificate, will satisfy or contribute to satisfying the various Regulations and related

Mandatory Standards as listed below.

|             |           |  |
|-------------|-----------|--|
| Regulation: | 8         | Fitness and durability of materials and workmanship  |
| Regulation: | 8(1)      | Fitness and durability of materials and workmanship  |
| Comment:    |           | The product can contribute to a construction meeting this Regulation. See sections 19.1 and 19.2 and the <i>Installation</i> part of this Certificate.   |
| Regulation: | 9         | Building standards – construction  |
| Standard:   | 1.1(a)(b) | Structure  |
| Comment:    |           | Walls will have adequate strength and stiffness to satisfy this Standard with reference to clause 1.1.1 <sup>(1)(2)</sup> and, when suitably reinforced, clause 1.2.1 <sup>(1)(2)</sup> . See sections 7.2, 7.3, 9.1 and 9.2 of this Certificate.  |
| Standard:   | 1.2       | Disproportionate collapse  |
| Comment:    |           | Walls will have adequate strength and stiffness to satisfy this Standard with reference to clause 1.1.1 <sup>(1)(2)</sup> and, when suitably reinforced, clause 1.2.1 <sup>(1)(2)</sup> . See sections 7.2, 7.3, 9.1 and 9.2 of this Certificate.  |
| Standard:   | 2.1       | Compartmentation   |
| Comment:    |           | Walls can satisfy the short, medium or long fire-resistance durations required by this Standard, with reference to clauses 2.1.2 <sup>(2)</sup> , 2.1.3 <sup>(2)</sup> , 2.1.5 <sup>(2)</sup> , 2.1.9 <sup>(2)</sup> , 2.1.10 <sup>(2)</sup> , 2.1.11 <sup>(2)</sup> , 2.1.12 <sup>(2)</sup> , 2.1.13 <sup>(2)</sup> , and 2.1.14 <sup>(2)</sup> . Openings in walls can maintain the required fire-resistance durations with reference to clause 2.1.15 <sup>(2)</sup> . Junctions between walls can maintain the fire-resistance durations with reference to clause 2.1.16 <sup>(2)</sup> . See section 16.1 of this Certificate. The expanded polystyrene component of the wall would be classified as combustible, however the completed wall can satisfy the required durations of fire-resistance with reference to clause 2.1.3 <sup>(2)</sup> . See sections 16.1 to 16.5 of this Certificate. |
| Standard:   | 2.2       | Separation   |
| Comment:    |           | Walls can satisfy the short, medium or long fire-resistance durations required by this Standard, with reference to clauses 2.2.1 <sup>(1)</sup> , 2.2.2 <sup>(1)(2)</sup> , 2.2.3 <sup>(1)(2)</sup> , 2.2.5 <sup>(1)(2)</sup> and 2.2.8 <sup>(1)</sup> . Junctions between walls can maintain the required fire-resistance durations with reference to clauses 2.2.7 <sup>(2)</sup> and 2.2.10 <sup>(1)</sup> . See section 16.1 of this Certificate. The expanded polystyrene component of the wall would be classified as combustible, however the completed wall can satisfy the required durations of fire-resistance with reference to clauses 2.2.4 <sup>(2)</sup> and 2.2.7 <sup>(1)</sup> . See sections 16.1 to 16.5 of this Certificate.   |
| Standard:   | 2.3       | Structural protection  |
| Comment:    |           | Walls can satisfy the short, medium or long fire-resistance durations required by this Standard, with reference to clauses 2.3.1 <sup>(1)(2)</sup> and 2.3.3 <sup>(1)(2)</sup> . Junctions between walls can maintain the required fire-resistance durations with reference to clauses 2.3.2 <sup>(1)</sup> and 2.3.5 <sup>(1)(2)</sup> . See section 16.1 of this Certificate.  |
| Standard:   | 2.4       | Cavities   |
| Comment:    |           | To limit the risk of fire spread by way of EPS formwork, detailing should address the need for sealing cavities in fire-resistant materials at junctions and edges of openings. Fire barriers should completely seal the cavity and be chased into the outer EPS formwork, with reference to clauses 2.4.1 <sup>(1)(2)</sup> to 2.4.7 <sup>(1)(2)</sup> , 2.4.8 <sup>(2)</sup> and 2.4.9 <sup>(2)</sup> . See section 16.3.  |
| Standard:   | 2.7       | Spread on external walls   |
| Comment:    |           | Walls can satisfy the reaction to fire required by this Standard, with reference to clause 2.7.1 <sup>(1)(2)</sup> provided the system is used in conjunction with suitable materials. See sections 16.1 and 16.3 of this Certificate.   |
| Standard:   | 3.4       | Moisture from the ground   |
| Comment:    |           | Walls can satisfy this Standard with reference to clauses 3.4.1 <sup>(1)(2)</sup> and 3.4.5 <sup>(1)(2)</sup> . See section 15.1 of this Certificate.  |

# Electronic Copy

|           |      |   |
|-----------|------|---|
| Standard: | 3.15 | Condensation  |
| Comment:  |      | Walls can adequately minimise the risk of surface condensation, with reference to clauses 3.15.1 <sup>(1)</sup> and 3.15.3 <sup>(1)</sup> . See section 12.1 of this Certificate. Walls can contribute to minimising the risk of interstitial condensation with reference to clauses 3.15.1 <sup>(1)</sup> and 3.15.4 <sup>(1)</sup> . See section 12.2 of this Certificate.  |
| Standard: | 5.1  | Resisting sound transmission to dwellings   |
| Comment:  |      | Separating walls satisfy this Standard, with reference to clauses 5.1.1 <sup>(2)</sup> , 5.1.2 <sup>(1)</sup> , 5.1.4 <sup>(1)</sup> and 5.1.6 <sup>(1)</sup> . See sections 13.1 to 13.3 of this Certificate.  |
| Standard: | 6.2  | Building insulation envelope  |
| Comment:  |      | Walls will meet the requirements of the Elemental Method for limiting heat loss, with reference to clause 6.2.1 <sup>(1)(2)</sup> . See section 10.1 of this Certificate. Walls can also adequately limit heat loss by unwanted air infiltration and excessive additional heat loss at junctions between walls, with other elements and around openings with reference to clauses 6.2.4 <sup>(1)(2)</sup> and 6.2.5 <sup>(1)(2)</sup> . See sections 10.5, 10.6, 11.1 and 11.3 of this Certificate.<br>(1) Technical Handbook (Domestic).<br>(2) Technical Handbook (Non-Domestic). |

## 3 The Building Regulations (Northern Ireland) 2000



In the opinion of the BBA, the Quad-Lock Insulating Concrete Formwork (ICF) System, if used in accordance with the provisions of this Certificate, will satisfy or contribute to satisfying the various Building Regulations as listed below.

|             |             |   |
|-------------|-------------|---|
| Regulation: | B2          | Fitness of materials and workmanship  |
| Comment:    |             | The product is acceptable. See sections 19.1 and 19.2 of this Certificate.  |
| Regulation: | C4(a)       | Resistance to ground moisture and weather   |
| Comment:    |             | Walls can adequately limit the risk of moisture ingress from the ground. See sections 7.2, 7.3, 13.1 to 13.3, 14 and 15.1 of this Certificate.  |
| Regulation: | C5          | Condensation  |
| Comment:    |             | Walls can contribute to minimising the risk of interstitial condensation. See sections 12.1 and 12.2 of this Certificate.   |
| Regulation: | D1          | Stability   |
| Comment:    |             | Walls will have adequate strength and stiffness to satisfy this Regulation. See sections 7.2, 7.3 and 9.1 of this Certificate   |
| Regulation: | D2          | Disproportionate collapse   |
| Comment:    |             | Walls, when suitably reinforced, will have adequate strength and stiffness to satisfy this Regulation. See sections 7.2, 7.3, 9.1 and 9.2 of this Certificate.  |
| Regulation: | E4(1)(2)(3) | Internal fire spread – Structure  |
| Comment:    |             | Walls can satisfy this Regulation. See sections 16.1 to 16.5 of this Certificate.   |
| Regulation: | F2          | Building fabric   |
| Comment:    |             | Walls will meet the requirements of the Elemental Method for limiting heat loss. See section 10.1 of this Certificate. Walls can also adequately limit heat loss by unwanted air infiltration and excessive additional heat loss around openings. See sections 10.7, 10.8, 11.1 and 11.4 of this Certificate. |
| Regulation: | G2(1)       | Separating walls and separating floors  |
| Comment:    |             | Separating walls can satisfy this Regulation. See sections 13.1 to 13.3 of this Certificate.  |

## 4 Construction (Design and Management) Regulations 1994 (as amended) Construction (Design and Management) Regulations (Northern Ireland) 1995 (as amended)

Information in this Certificate may assist the client, planning supervisor, designer and contractors to address their obligations under these Regulations.

See sections: 6 *Site handling and storage* (6.4) and 8 *Practicability of installation* (8.1 to 8.3).

## Technical Specification

### 5 Description

5.1 The Quad-Lock Insulating Concrete Formwork (ICF) System consists of expanded polystyrene (EPS) panels, high-density polyethylene interconnecting and metal spacers (ties), metal tracks (toe rails) and metal corner brackets. The panels are made from high-density, fire-retardant expanded polystyrene beads and are

produced in thicknesses of 57 mm and 108 mm. The top and bottom of each panel incorporate an interlocking arrangement to form a tight joint. Slots, at 51 mm centres, are also incorporated in the top and bottom to receive the plastic spacers. Grooves are also moulded into the outside face of each panel to indicate the position of the spacer flanges. An internal vertical rebate is also provided to form the wall corners. The vertical ends of the panels are smooth (see Figure 1).

# Electronic Copy

5.2 The system can be used to construct straight and curved walls (minimum radius 885 mm to inside face) (see Figure 2) with right, obtuse and acute angles.

5.3 Spacers are moulded from high-density polyethylene (HDPE) and are colour coded in lengths of 191 mm, 241 mm, 292 mm, 343 mm and 394 mm wall thickness as indicated in Table 1. Three special ties (see Figure 1), slab edge tie, extender tie and brick ledge tie are also provided as part of the system. Steel reinforcement can be fixed directly to the spacer web. Flanges incorporated within the spacer design provide a fixing for dry lining, cladding and temporary propping or bracing (see section 9.3). Spacers are placed at 305 mm centres generally or closer at corners, openings or highly stressed areas. In these situations spacers can be split to allow close centres to be achieved.

5.4 Wire top ties are bent from 5 mm diameter galvanized wire and are used to provide additional support to tops of assembled panels (see Figure 1).

Figure 1 Quad-Lock System elements

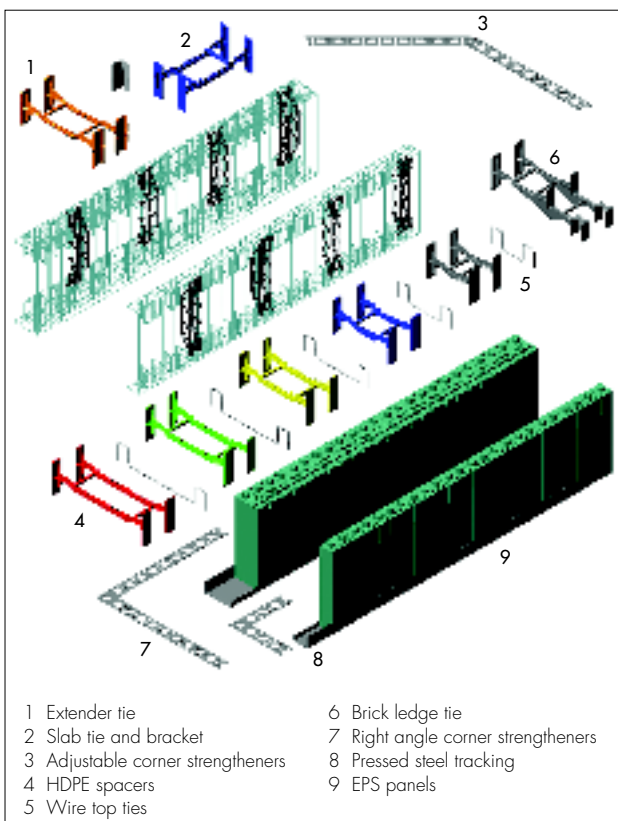

Figure 2 Curved wall detail

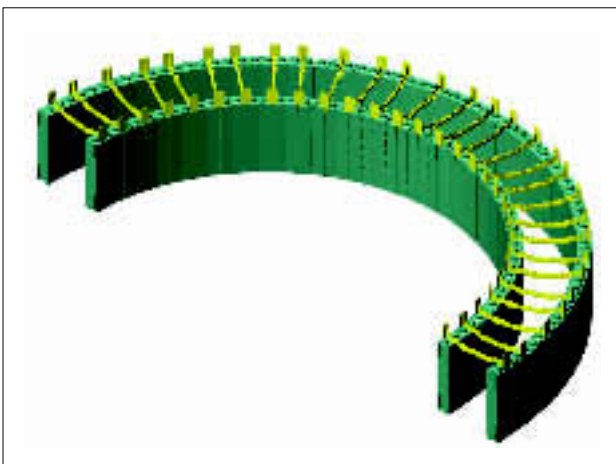

Table 1 Wall thicknesses

| Nominal wall cavity<br>(concrete width – mm) | Overall wall width<br>(mm) |
|--|----------------------------|
| 100  | 210                        |
| 150  | 260                        |
| 200  | 311                        |
| 250  | 362                        |
| 300  | 413                        |

5.5 Pressed steel tracking is available in 57 mm and 108 mm widths and rolled from 1 mm thick galvanized steel sheet (Z275 galvanize specification) (see Figure 1). Tracking is used at the base of the wall construction, to provide a locating position and aid stability during concrete pouring operations, and at top of panel assemblies to protect panel joints from wet concrete and provide temporary stability.

5.6 Inner and outer 90° corners are strengthened during the concrete pour by 24 gauge, galvanized steel brackets and this eliminates the use of external bracing. Adjustable brackets are used for outer face of obtuse angle corners.

5.7 The EPS panels have a nominal density of 24 kgm<sup>-3</sup> (for the 108 mm thick panel) or 30 kgm<sup>-3</sup> (for the 57 mm thick panel).

5.8 Upper and lower surfaces are moulded to lock panels together (see Figure 3). Vertical mating surfaces are smooth to form a flush fit when joined together.

Figure 3 Basic assembly

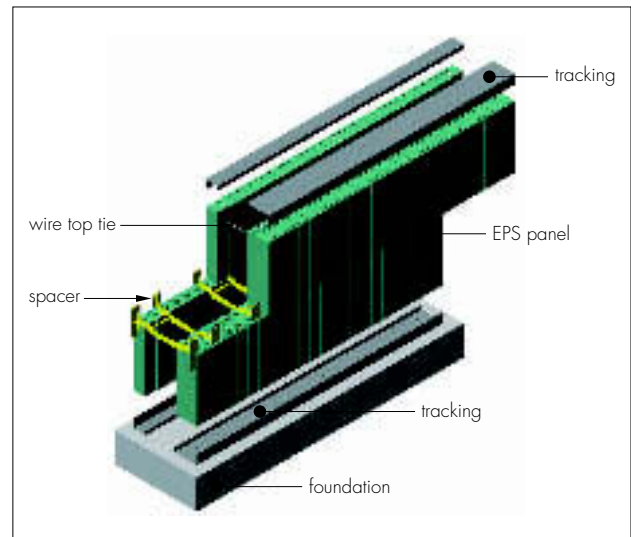

5.9 Elements are dry laid in staggered vertical joints (brick bond). The surfaces are smooth and grooved vertically (with the grooved face outside), depending on finishes required. The formwork requires alignment and support during concrete filling.

5.10 Concrete, typically Grade C35 for general work, is specified to BS EN 206-1 : 2000. The recommended aggregate size is 10 mm for the nominal wall thickness of 100 mm and 150 mm and 20 mm for the 200 mm and 300 mm nominal wall thickness. The concrete should contain an admixture complying with BS EN 934-2 : 2001 to allow placement either by rodding or by free flow. Specific concrete mixes, eg water-resisting concrete for basement use, are dependent on individual requirements and are outside the scope of this Certificate. Vibrating equipment should be used with care (see section 21.14).

# Electronic Copy

5.11 Components and finishes used in conjunction with the formwork but not covered by this Certificate are:

- steel reinforcement — where required, should comply with BS 4449 : 2005
- external render — in accordance with BS 5262 : 1991 and suitable for use with the system. Typically the render has a basecoat of cement, sand and polymer reinforced, with either a stainless steel lath, polypropylene mesh, or an alkaline-resistant glass-fibre mesh
- acrylic render — the Certificate holder is able to advise on suitable acrylic render products for use with the system
- brick or stone slips — the Certificate holder's advice should be sought on suitable products and methods of fixing
- external masonry — may be of brickwork or stonework fixed in accordance with the provisions of BS 5628-3 : 2005 or BS 8298 : 1994 respectively
- internal finish — typically 12.5 mm thick plasterboard or a dry-lined finish with or without a plaster skim coat conforming to BS 8212 : 1995.
- brickwork/stonework wall ties and support systems — to BS EN 845-1 : 2003 or as recommended by the Certificate holder
- trestle support system — as supplied by the Certificate holder
- basement waterproofing membrane — see section 7.7
- wall ties — wall ties to BS 845-1 : 2003 or similar approved by the Certificate holder.

## 6 Site handling and storage

6.1 Good site practice should be observed to prevent damage to the components.

6.2 The EPS components are supplied in tightly wrapped packs and wrapping should not be opened until the contents are required. Metal toe rails are supplied in banded packs. Interconnecting high-density polyethylene spacers are supplied in boxes with the installation instructions printed on the outside.

6.3 EPS packs should be stored on their sides to protect the toothed edges from damage.

6.4 Care must be taken when handling the panels to avoid damage and contact with solvents or materials containing volatile organic components such as newly treated timber. The elements must not be exposed to open flame or other ignition sources.

## Design Data

### 7 General

7.1 The Quad-Lock Insulating Concrete Formwork (ICF) System is satisfactory for use in loadbearing and non-loadbearing walls as permanent formwork for in-situ dense aggregate concrete (see Figure 4).

7.2 Buildings subject to the national Building Regulations should be constructed in accordance with the relevant recommendations of CP 102 : 1973, BS 8110-1 : 1997 and BS 8102 : 1990.

7.3 Other buildings not subject to any of the Regulations defined in section 7.2 should also be built in accordance with CP 102 : 1973, BS 8110-1 : 1997 and BS 8110-2 : 1985.

Figure 4 Typical detail — Wall on ground-floor slab

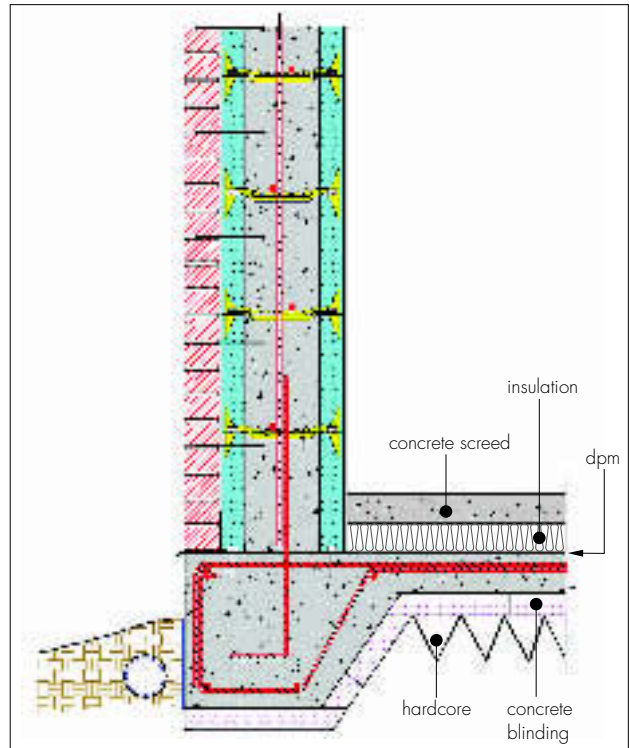

7.4 The concrete is not easily examined after casting, hence, as specified in BS 8110-1 : 1997, Section 2, care must be taken to ensure full compaction. Correct compaction can be checked by the use of a 'blunt-needle' depth gauge pushed into the EPS panels to detect voids. Particular attention should be given to basement walls and areas adjacent to formed openings. Voids may be detected during the concrete placement, by hitting the EPS panels (eg with the palm of the hand or a wooden mallet) and listening for a 'hollow' sound otherwise concrete cores can be taken once concrete has reached initial design strength. Suitable supervision must be provided during placing and compacting of the concrete.

7.5 Storey-height concrete walls are normally constructed in one lift. Particular care is necessary to maintain alignment during concrete filling, and checking between lifts. Propping systems used in conjunction with the ICF system must be checked prior to and during concreting filling to ensure stability and alignment is maintained.

7.6 The *Quad-Lock ICF Product Manual* should be consulted in respect of use of poker vibration for compaction of wet concrete (see also section 21.14).

7.7 When used for basement or retaining wall construction with general concrete mixes, an effective, external waterproofing membranes should be employed, ensuring correct detailing and jointing methods to manufacturer's instructions and in accordance with the *Quad-Lock ICF Product Manual* recommendations. Waterproofing methods have not been assessed by the BBA nor are they covered by this Certificate.

### 8 Practicability of installation

8.1 Installation of the formwork, including the forming of door and window openings using timber framing or extruded, recycled plastics, should be carried out by trained operatives. The panels can be cut using conventional woodworking tools.

8.2 Concrete can be placed by hand, by skip (with adapted neck) line pump or overhead boom. The

requirements given in sections 21.11 to 21.14 of this Certificate must be observed during placing and compacting of the concrete. Care should be taken to avoid pump surges that may locally overload the formwork.

8.3 Durable and mechanically adequate fixings (see Figure 5) must be used for all structural elements or support brackets and must be post-drilled or cast into the concrete core. The EPS forming each of the system components must not be used as a structural medium although fixing/spacer flanges as described in section 5.3 can be used. In specifying wall fixings carrying vertical loads, consideration should be given to the line of action of the load with respect to the face of the concrete wall and the effect on the strength of the fixing.

Figure 5 Ledger form

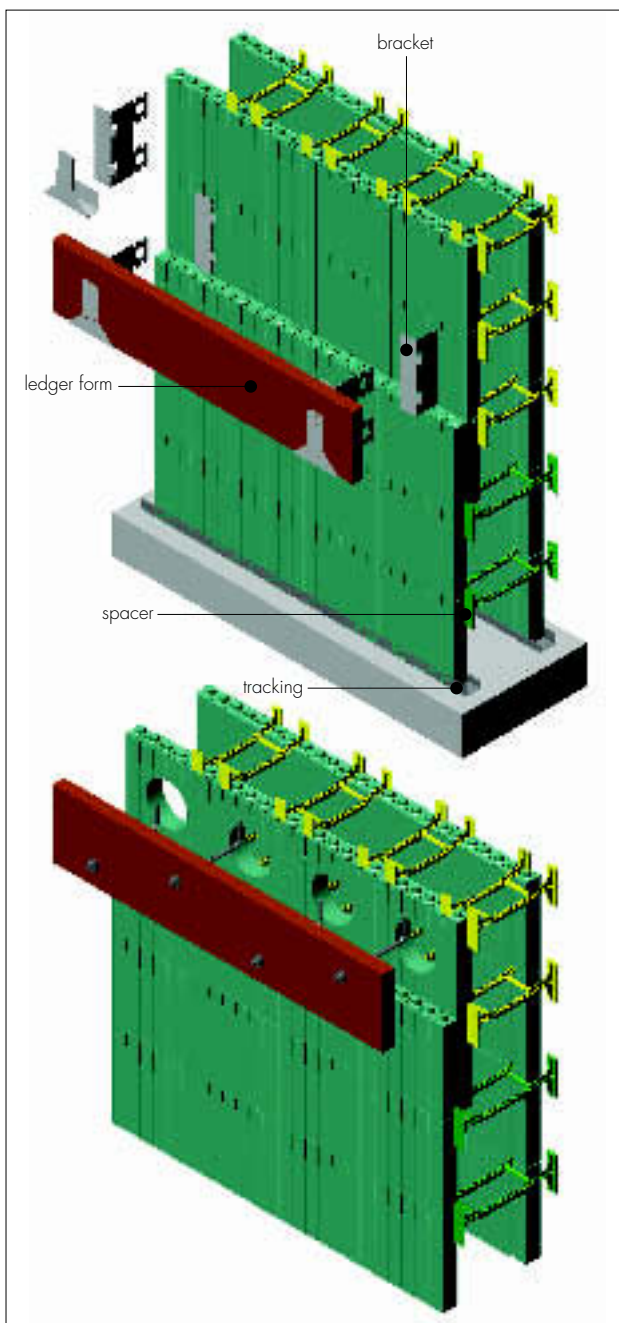

8.4 Consideration should be given at the design stage to the positioning of wall fixings, service pipes and joists, relative to the position of connecting assemblies. They can be incorporated by following the manufacturer's recommendations. Care must be taken

not to damage the elements and thermal bridging effects must be considered.

8.5 Electrical wiring conduits and small diameter pipework should only be installed in chases routed into the EPS panels if unavoidable, as this can lead to local thermal bridging. Bare wiring must not be in contact with the EPS.

8.6 Facing brickwork or stonework should be fixed to the concrete with suitable ties (also see section 5.11). Fixings should be applied to the depth recommended by the manufacturer. Ledger forms and connectors are available for the fixing of floor construction (see Figure 4).

8.7 Timber weatherboarding and hung tiles should be fixed to treated battens secured to the in-situ concrete as described in section 5.3 and in accordance with the *Quad-Lock Product Manual*.

## 9 Structural strength and stability

9.1 Walls constructed using the system may be treated as conventional concrete plain or reinforced walls and should be designed and constructed in accordance with the recommendations of BS 8110-1 : 1997 and BS 8110-2 : 1985. Particular attention should be made to the use of the type of concrete mix to ensure segregation does not occur and that wet concrete is allowed to flow freely around formed openings and through congested areas of reinforcement, particularly when the system is used in basement construction. The Certificate holder is able to provide suitable design advice on request.

9.2 The nominal concrete cover to reinforcement should be that appropriate to 'mild' exposure in accordance with BS 8110-1 : 1997, Tables 3.2 and 3.4, or as required for fire-resistance in accordance with BS 8110-2 : 1985, Section 4, whichever is the greater.

9.3 To achieve structurally-stable formwork during the construction process the system must be braced sufficiently to resist the loads imparted on the system by the wet concrete and other construction loads. Although timber bracing can be used, the Certificate holder recommends use of a specially designed scaffolding system (see Figure 6) designed to give lateral alignment and support during the pouring of the concrete and post-pouring stage. The system also provides a platform for operatives and includes screw props for adjustment purposes both prior to and immediately following pouring operations.

Figure 6 Temporary propping

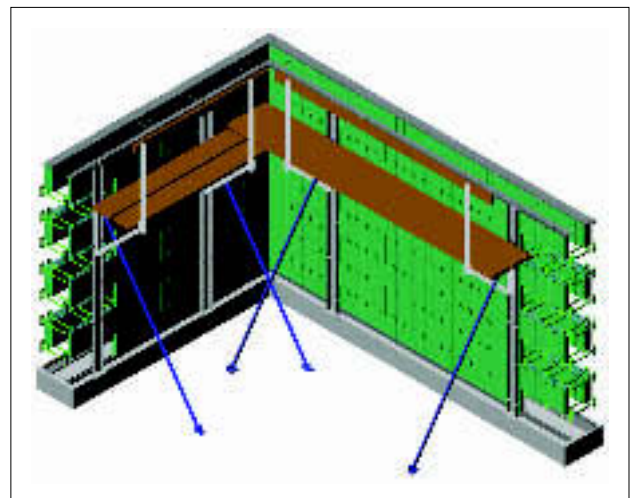

9.4 Attention is drawn to the need for accurate levelling of the foundation and initial setting out of the bracing (see sections 20.2 and 20.5) which should prevent the need for significant adjustments to be made.

### 10 Thermal performance

 10.1 The thermal transmittance (U value) of an external wall construction, typically, will be in the range of from  $0.15 \text{ Wm}^{-2}\text{K}^{-1}$  to  $0.28 \text{ Wm}^{-2}\text{K}^{-1}$  depending on the polystyrene panels and the type of internal and external finishes used. Calculations for specific constructions should be carried out in accordance with BS EN ISO 6946 : 1997 and BRE report (BR 443 : 2006) *Conventions for U-value calculations*. The thermal conductivity of the polystyrene panels should be taken as  $0.035 \text{ Wm}^{-1}\text{K}^{-1}$ .

 10.2 External walls, typically, can improve on the Elemental U value requirement of the Building Regulations (ie  $0.35 \text{ Wm}^{-2}\text{K}^{-1}$ ) by between 20% and 57% and, therefore, will contribute to enabling a building to meet the Target Emission Rate 'average' improvements of 20% (dwellings) and between 23% and 28% (buildings other than dwellings) specified in Approved Documents L1A and L2A respectively.

10.3 Junctions between external walls and between external walls and party walls will maintain insulation continuity and the default psi values from BRE Information Paper (IP 1/06 : 2006) *Assessing the effects of thermal bridging at junctions and around openings in the external elements of buildings*, Table 3 and SAP 2005 *The Government's Standard Assessment Procedure for Energy Rating of Dwellings*, Table K1, may be used in Target Emission Rate calculations to SAP 2005 or the Simplified Building Energy Model (SBEM)<sup>(1)</sup>.

(1) Published by the Office of the Deputy Prime Minister (ODPM) on its website: [www.odpm.gov.uk](http://www.odpm.gov.uk)

10.4 Junctions with other elements and openings in external walls, should be designed in accordance with the relevant guidance given in *Limiting thermal bridging and air leakage : Robust construction details for dwellings and similar buildings*<sup>(1)</sup> or IP 1/06.

(1) Published by The Stationery Office (TSO), 2002.

 10.5 External walls can satisfy the Elemental Target U value of  $0.30 \text{ Wm}^{-2}\text{K}^{-1}$  specified in the Building Regulations, with reference to clause 6.2.1<sup>(1)(2)</sup>.

(1) Technical Handbook (Domestic).

(2) Technical Handbook (Non-Domestic).

10.6 Junctions with other elements and openings in external walls, should be designed to limit heat loss. Guidance given in BRE report (BR 262 : 2006) *Thermal insulation : avoiding risks* or IP 1/06 : 2006 is acceptable.

 10.7 External walls can satisfy the Elemental Target U value of  $0.45 \text{ Wm}^{-2}\text{K}^{-1}$  specified in the Building Regulations Technical Handbook F, Tables 1.2 and 1.4.

10.8 Openings in external walls, should be designed to limit heat loss. Guidance given in BRE Information Paper (IP 12/94) *Assessing condensation risk and heat loss at thermal bridges around openings* may be used.

 11.1 External walls can provide adequate resistance to heat loss by air infiltration. Care should be taken to ensure that junctions with other elements and openings in external walls, comply with the relevant guidance for airtightness given in the relevant documents referred to in section 10.4 or 10.8.

 11.2 Completed buildings are subject to pre-completion testing for airtightness in accordance with the requirements of the Building Regulations, Approved Documents L1A and L2A, Section 20B.

 11.3 Junctions with other elements and openings in external walls, with reference to clauses 6.2.4<sup>(1)(2)</sup> and 6.2.5<sup>(1)(2)</sup> of the Technical Handbooks, should be designed to limit air infiltration (see section 10.8).

(1) Technical Handbook (Domestic).

(2) Technical Handbook (Non-Domestic).

 11.4 Junctions with other elements should be designed to limit air infiltration as described in the Building Regulations, Technical Booklet F, section 1.35.

### 12 Condensation

#### Surface condensation

 12.1 External walls will adequately limit the risk of surface condensation. Openings in walls and junctions with other elements, designed in accordance with the relevant guidance given in section 10 will also be acceptable.

#### Interstitial condensation

12.2 The risk of interstitial condensation will be minimal when a suitably positioned vapour control layer is used. For the purposes of calculating condensation risk in accordance with BS 5250 : 2002, a nominal vapour diffusion factor ( $\mu$ ) of 60 (a vapour resistivity of  $300 \text{ MNsg}^{-1}\text{m}^{-1}$ ) may be taken for the polystyrene panels.

### 13 Sound insulation

 13.1 Separating walls with a concrete core density greater than  $2000 \text{ kgm}^{-3}$  and thickness of 150 mm, will achieve a minimum mass per unit area for the core of  $300 \text{ kgm}^{-2}$ . When used in conjunction with suitable framing, lining and flanking details, the wall can meet the requirements of a wall Type 3.

13.2 Separating walls in dwellings and rooms for residential purposes in England and Wales are subject to pre-completion testing in accordance with Section 1 of Approved Document E.

13.3 Internal walls and walls flanking separating walls in new dwellings and rooms for residential purposes will have a minimum mass per unit area, excluding finishes, of  $120 \text{ kgm}^{-2}$ .

### 14 Weathertightness

 Resistance to rain ingress is provided by the external weather cladding system. Typical options are described in section 5.11. Care should be taken to ensure that design and construction are suitable for use with the system and comply with the relevant good practice described in the applicable Codes and the Certificate holder's instructions.

## 15 Damp-proofing and waterproofing

15.1 The system's elements will not transmit moisture by capillary action. To provide effective damp-proofing or waterproofing, a concrete wall formed with the system should be constructed using the specified concrete in accordance with Type B structures — structures without membrane in BS 8102 : 1990 (see also section 7.2 of this Certificate).

15.2 Alternatively, when used below ground or formation level, eg basement or retaining wall, a number of options can be used to provide a watertight barrier. These options are outside the scope of this Certificate and the Certificate holder should be contacted for further advice. Any waterproofing barrier system used, must be compatible with EPS.

15.3 A suitable collector drain and backfilling medium should be provided to eliminate the build up of hydrostatic head behind basement or retaining walls.

## 16 Behaviour in relation to fire

16.1 Concrete walls constructed from the system have been assessed in accordance with Table 4.6 of BS 8110-2 : 1985. Table 2 of this Certificate gives fire-resistance values for various concrete wall thicknesses formed using the system elements. This assessment does not take account of any additional protection provided by the internal and external finishes. The use of the formwork with the specified finishes will not reduce the fire-resistance of the concrete wall.

*Table 2 Quad-Lock system walls with vertical reinforcement<sup>(1)</sup>*

| Reinforcement and concrete specification   | Minimum concrete thickness <sup>(2)</sup> (mm) |     |     |     |     |     |
|--|--|-----|-----|-----|-----|-----|
|  | Fire resistance <sup>(3)</sup> (h)             |     |     |     |     |     |
|  | 0.5  | 1   | 1.5 | 2   | 3   | 4   |
| Walls with less than 0.4% reinforcement made from dense aggregate                                  | 150  | 150 | 200 | —   | —   | —   |
| Walls with 0.4% to 1% reinforcement made from dense aggregate with cover to reinforcement of 25 mm | 100  | 150 | 150 | 200 | 200 | 250 |

- (1) Where reinforcement is less than 0.4%, any wall with less than 100 mm thick concrete cannot be assumed to provide the minimum level of fire-resistance required by Regulations (30 minutes). Whilst the plasterboard lining will provide some protection, no data has been supplied to permit assessment of this specific case.
- (2) Excluding any combustible finish.
- (3) Fire resistance for loadbearing capacity, integrity and insulation.

16.2 The expanded polystyrene component of the system would not be classified as non-combustible. For buildings in Scotland, completed walls with appropriate finishes can satisfy the required durations of fire-resistance and, therefore, maybe used in separating walls. Where external walls are one metre or less from a relevant boundary, the construction should comply with the relevant exceptions on the use of combustible materials permitted by the guidance supporting the Building Regulations in Scotland.

16.3 The risk of fire spread over the internal and external wall surfaces will depend on the finishes that are used. The relevant requirements of the national Building Regulations should be observed. In Scotland, the guidance for fire spread on external walls of buildings should not be assessed in isolation and reference should be made to the guidance in Standard

2.4 for fire spread in cavities and the guidance in Standard 2.6 for fire spread to neighbouring buildings.

16.4 To limit the risk of fire spread between floors in buildings subject to the Building Regulations in England and Wales, fire barriers should be installed at each floor level above the first floor, ie starting with the second storey. Fire barriers should completely seal the cavity and be chased into the outer EPS formwork.

16.5 In buildings other than those described in section 16.4, it is recommended that designers consider the guidance given in that section.

16.6 Care should be taken to ensure that all detailing at junctions adequately maintains the required periods of fire-resistance, that any cavities formed in the completed walls are appropriately fire stopped and detailing around any openings provides sufficient protection to the EPS.

## 17 Proximity of flues and appliances

When installing the product in close proximity to certain flue pipes and/or heat-producing appliances the following provisions to the national Building Regulations are acceptable:

### England and Wales

Approved Document J3

### Scotland

Technical Handbook (Domestic), Mandatory Standards 3.18, clauses 3.18.1<sup>(1)(2)</sup> to 3.18.6<sup>(1)(2)</sup> and 3.19, clauses 3.19.1<sup>(1)(2)</sup> to 3.19.9<sup>(1)(2)</sup>.

(1) Technical Handbook (Domestic).

(2) Technical Handbook (Non-Domestic).

### Northern Ireland

Technical Booklet L.

## 18 Maintenance and repair

18.1 Although maintenance is not envisaged for the system, regular checks should be carried out on render finishes used to ensure that any damage is detected and repaired as soon as possible.

18.2 Minor repairs to the system can be carried out prior to concrete pouring using expanding foam, supplied by the Certificate holder, to reduce leakage of wet concrete and maintain the thermal integrity of the EPS.

## 19 Durability

19.1 Concrete walls constructed with the system will have a service life of not less than 60 years provided they are designed in accordance with section 9. The EPS formwork will have a similar service life provided that it is protected from damage by the external and internal finishes of the wall construction and these are adequately maintained throughout the intended life of the building.

19.2 The HDPE spacers are conventional building materials and will have a durability compatible with the expanded polystyrene.

## Installation

## 20 General

20.1 The preparation, installation and support of the panels and application of the specified finishes must be in accordance with the *Quad-Lock ICF Product Manual*. Particular attention must be given to the requirements given in sections 8.1 to 8.7 of this Certificate.



## 21 Procedure

### Laying

20.2 The system requires that the foundation be level, smooth finished and within a tolerance of  $\pm 10$  mm in any direction. Any out-of-tolerances must be made good prior to placement of formwork.

20.3 All reinforcement should be accurately positioned to ensure that the minimum required concrete cover is provided. Starter or dowel bars, where required, must be to the engineer's design. HDPE spacers should not be cut or modified when locating reinforcement.

20.4 When stepped foundations are required, 305 mm steps should be provided to avoid cutting forms.

20.5 It is essential that effective bracing and propping of walls takes place during construction to ensure stability, level, straightness and plumb of walls. The Certificate holder recommends the use of a patent metal bracing system (not covered by this Certificate). The system includes a vertical aluminium support channel, diagonal turnbuckle brace, platform bracket and guardrail post assembly. Bracing and alignment systems, should be between 1.8 m and 2 m horizontal centres but subject to verification by calculation depending on wall configuration.

20.6 Typically, for single storey lifts, the bracing and alignment systems are placed on one side of the formwork (usually the inside face) during construction. For other formwork constructions an engineer's advice should be sought.

20.7 Window and door openings are formed during construction of the formwork. Treated timber or extruded recycled plastics framework is placed around openings and between EPS panels to seal openings during concrete pouring. To ensure that the framing remains square, internal bracing should be provided (see Figure 7). The framework is used to receive door and window frames.

Figure 7 Typical structural window framing

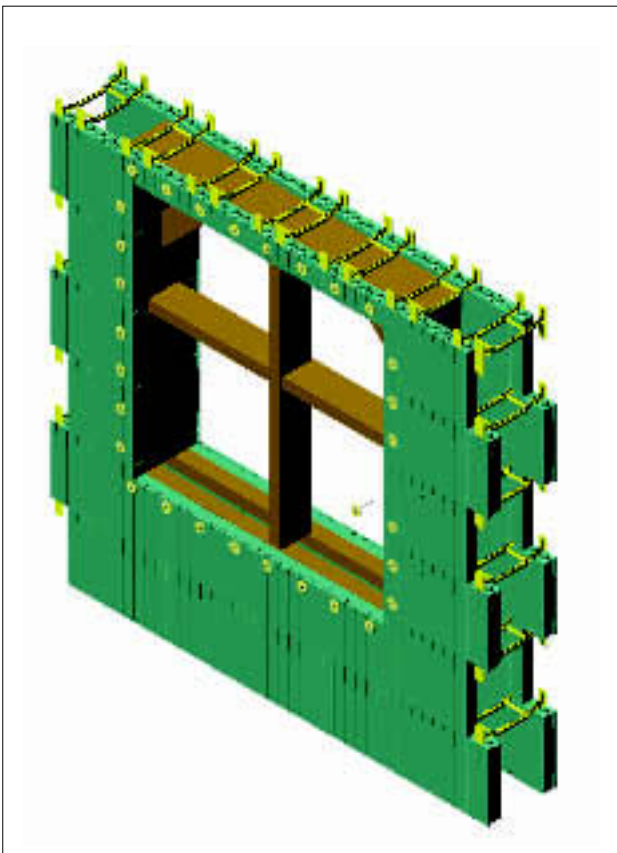

21.1 The inner and outer lines of metal tracking are first fastened to the footing using masonry nails (or other suitable fixings) and lined level. Any gaps beneath the tracking are filled with low expansion polyurethane foam.

21.2 Construction commences by forming the corners and then working inwards towards the mid-point of each wall line. The long end (1220 mm) of the corner form should be used first maintaining a running bond. With the first course it is also important to run the forms through door and deep window openings (these can be cut out later) so that interlocking of forms is maintained above each opening. The short end (616 mm) should be used next and alternated until each wall assembly is completed.

21.3 Vertical joints formed at the mid-point of walls must be sealed with expanding foam on both sides. The foam should be allowed to set for at least 12 hours prior to pouring. Plywood plates or similar should be provided across mid-wall joints to provide additional strengthening during concrete pouring.

21.4 All 90° corners are provided with inside and outside corner brackets to each course. Other corner angles are strengthened with the adjustable corner bracket on the outside only.

21.5 Following completion of the first course, subsequent courses are laid in a running bond.

21.6 Internal wall formwork is jointed into external formwork by removal of a vertical slice (see Figure 8).

Figure 8 Horizontal internal-external separating wall joint

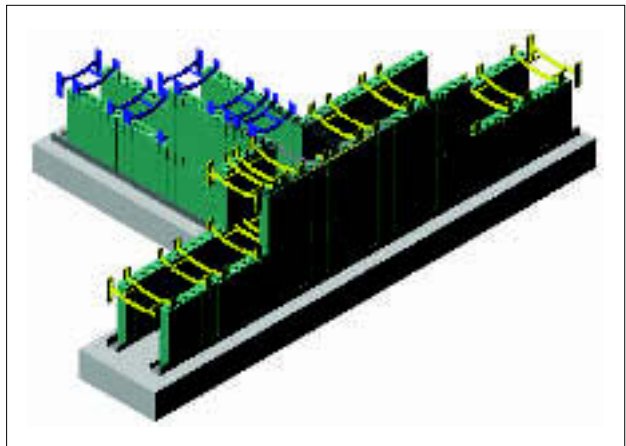

### Reinforcement

21.7 The quantities of reinforcement placed within the system are dependent on design and detail requirements. Horizontal reinforcement can be placed in different locations across the concrete fill void using the spacer slots. Vertical reinforcement can then be placed against the horizontal reinforcement and secured using standard fixing methods. Bar lapping lengths as per BS 8110-1 : 1997 should be adopted. The system requires that in plain walls horizontal reinforcement be provided in top and bottom courses of every wall lift. Generally, high tensile reinforcement is used. Typical lintel reinforcement is shown in Figure 9.

### Restraint and propping

21.8 Restraint is provided by securing the bottom course to the foundation using, galvanized steel, tracking shot-fired or screwed into the foundation. The patent bracing, system or other suitable propping system

# Electronic Copy

is then erected. Additional bracings are also recommended for basement walls. Bracings should be located so as not to interfere with door and window openings. All bracings are then anchored to the ground-floor slab or firm ground with the aluminium channel or other support screw fixed into the spacer flanges.

Figure 9 Typical window opening detail

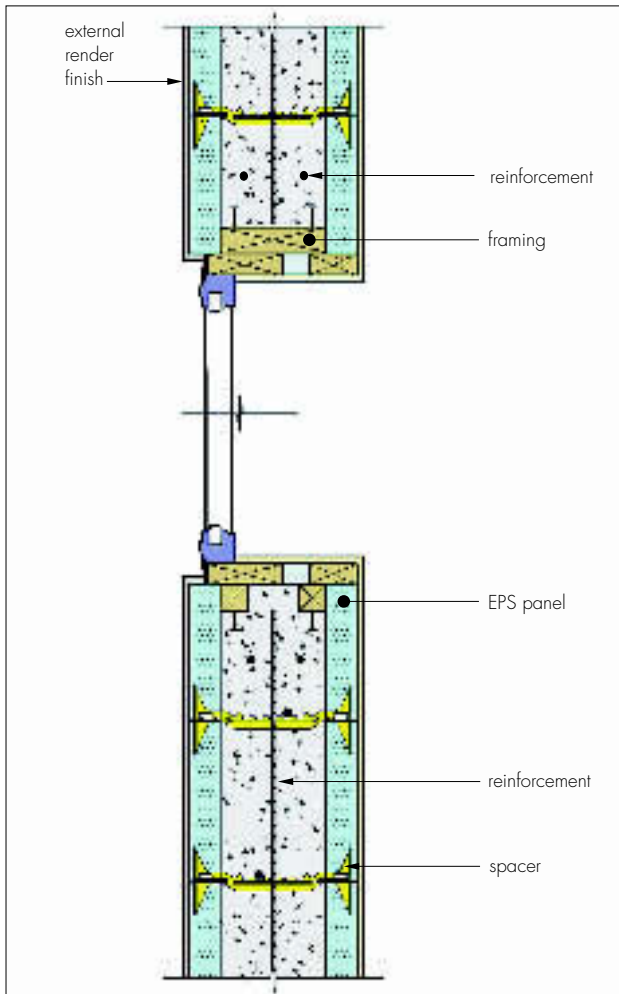

21.9 After erection of the bracing and propping, adjustments are made for plumb and level by use of screw jacks.

## Windows and doors

21.10 Window and door openings are set out on the face of the formwork and opening cut using a handsaw. Timber framing is set around the door frames, pre-set prior to the wall assembly, and the panels built up to the opening and braced (see Figure 7). Note that the sill part of the framing to window openings can be omitted, to avoid the potential formation of voids beneath the timber framing. If omitted, the concrete poured up to sill level must be allowed to stiffen sufficiently so as to avoid overflow as subsequent concrete is poured.

## Concrete placement

21.11 Prior to concrete pouring, a check should be carried out on the system to include conformance to design and layout, correct alignment and plumb, bracings and props secured. Reinforcement should be checked for correct cover distance and rigidity. A pre-pour checklist is set out in the Certificate holder's *Product Manual*.

21.12 Concrete is typically placed using line pump or overhead boom from a concrete pump lorry. Small

volumes of concrete can be placed by hand, eg to make up small deficiencies at the end of each pour.

21.13 Concrete placement should be directed away from corners traversing the line pump or boom first around the external walls of the building in 1200 mm lifts allowing concrete to free-flow into corners and below window openings. The first lift is allowed to stiffen before placing the second lift of concrete. Typically storey heights should be placed in two- to three lifts.

21.14 Consolidation can be achieved by the use of special flow concrete mixes or small diameter poker vibrators. Special care is required to avoid touching the formwork when using the latter equipment. Hand rodding to local areas and external vibration around openings can also be employed, with care, to avoid damaging the formwork. Metal tracking and wire top ties (see Figure 1) are used to final course of panels (ie at eaves or gable line) in lieu of HDPE spacers. The panel top joint toothing is removed where the tracking is to be permanent otherwise following the pouring and stiffening of concrete the tracking can be removed. This may also be necessary to avoid thermal bridging leading to condensation in completed building. At corners the tracking should be overlapped and screwed to provide additional stiffening to corner during concrete pouring. The metal tracking can also be used as temporary protection at each wall assembly lift to minimise concrete spilling into joint toothing.

## Backfilling

21.15 Backfilling around bottom layers of formwork to the ground floor or basement walls should not take place until the concrete has reached sufficient design strength. The Certificate holder recommends a minimum period of 28 days. The top of basement walls must be supported by temporary supports or by utilizing the floor construction on the basis that the floor/wall joint allows full transfer of loads through diaphragm action.

## Electrical and plumbing installation

21.16 Electrical and plumbing services may be located within the concrete core, subject to structural design consideration. For chasing into the EPS panels see section 8.5. All electrical services should be ducted. Any services introduced should conform to Building Regulation and Health and Safety requirements. Further details on fixing methods can be obtained from the Certificate holder.

## Wall penetrations

21.17 Openings or ducts for service penetrations can be positioned within the formwork prior to concrete pouring. Service entry points to basement walls should be avoided.

## Intermediate floors and roof

21.18 A range of floor and roof systems can be accommodated with the system. Further details can be obtained from the Certificate holder.

## Interior and external finishes

21.19 A range of external and internal finishes can be applied or fixed directly to the system. Common dry lining systems, such as gypsum plasterboard, can be screw-fixed into the form tie/spacer flanges or glued to EPS using compatible adhesive. External cladding systems can be fixed similarly via battens, rails or into form tie/spacer flanges or with renders applied directly to the EPS surface in conjunction with metal or plastic lathing. Finishes are outside the scope of this Certificate. Further

details on finishes suitable for use with the ICF system, can be obtained from the Certificate holder.

## Wall width transitions

21.20 Wall width transitions can be achieved by using one course of the thicker panel as shown in Figure 5.

## Waterproofing

21.21 The system relies on an externally applied waterproofing system to provide an effective barrier to the ingress of ground water to basement walls. Full details can be obtained from the Certificate holder. A typical detail is shown in Figure 10.

Figure 10 Typical external waterproofing detail

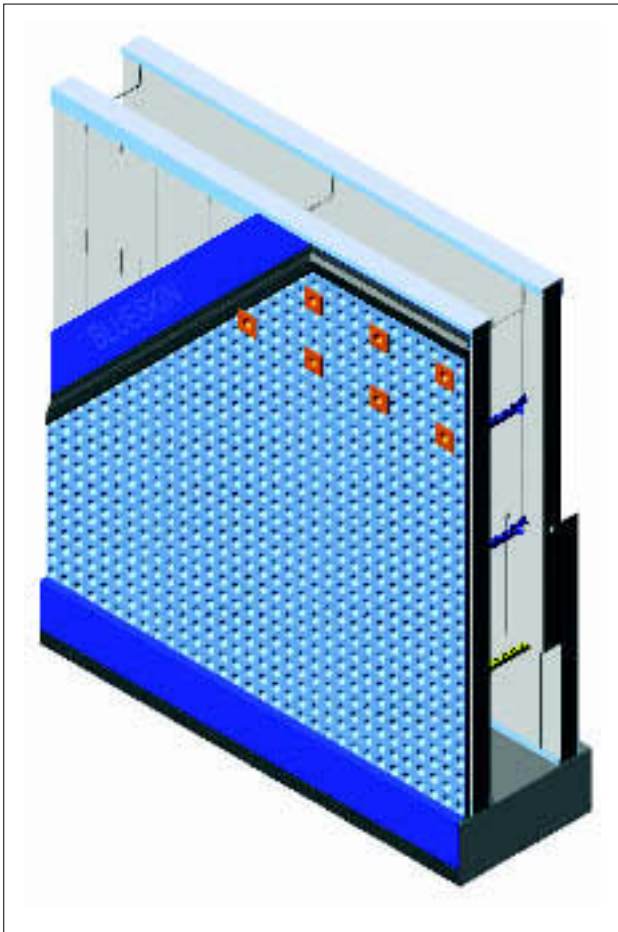

## Heavy wall loads

21.22 Heavy wall loads (such as wall units) should be supported by the concrete core and not the form tie/spacer flanges. This can be achieved by the use of timber blocks screwed or bolted into the concrete core or cast-in anchor bolts and metal plates.

## Brick ties

21.23 Suitable wall ties to stabilise brick, block or stone external leaves.

## Technical Investigations

The following is a summary of the technical investigations carried out on the Quad-Lock Insulating Concrete Formwork (ICF) System.

## 22 Tests

Tests in broad accordance with the requirements of ETAG 009 : 2002 were carried out on the system as part of normal construction under site conditions. Observations were made on dimensional accuracy

resistance to filling pressure and efficiency of filling including the potential for outwards deflection of formwork due to the hydrostatic head of wet concrete.

## 23 Investigations

23.1 A site visit was carried out to witness the installation process including construction of formwork, placement of reinforcement and pouring of concrete and performance of form tie/spacers.

23.2 An assessment was made on technical data relating to fire and thermal performance.

23.3 The manufacturing process was examined, including the methods adopted for quality control and details were obtained of both quality and composition of materials.

## Bibliography

BS 4449 : 2005 *Steel for the reinforcement of concrete — Weldable reinforcing steel — Bar coil and decoiled product — Specification*

BS 5250 : 2002 *Code of practice for control of condensation in buildings*

BS 5262 : 1991 *Code of practice for external renderings*

BS 5628-3 : 2005 *Code of practice for use of masonry — Materials and components, design and workmanship*

BS 8102 : 1990 *Code of practice for protection of structures against water from the ground*

BS 8110-1 : 1997 *Structural use of concrete — Code of practice for design and construction*

BS 8110-2 : 1985 *Structural use of concrete — Code of practice for special circumstances*

BS 8212 : 1995 *Code of practice for dry lining and partitioning using gypsum plasterboard*

BS 8298 : 1994 *Code of practice for design and installation of natural stone cladding and lining*

BS EN 206-1 : 2000 *Concrete — Specification, performance, production and conformity*

BS EN 845-1 : 2003 *Specification for ancillary components for masonry — Ties, tension straps, hangers and brackets*

BS EN 934-2 : 2001 *Admixtures for concrete, mortar and grout — Concrete admixtures — Definitions, requirements, conformity, marking and labelling*

BS EN ISO 6946 : 1997 *Building components and building elements — Thermal resistance and thermal transmittance — Calculation method*

CP 102 : 1973 *Code of practice for protection of buildings against water from the ground*

ETAG 009 : 2002 *Guideline for European Technical Approval of non-loadbearing permanent shuttering kits/systems based on hollow blocks or panels of insulating materials and sometimes concrete*

## Conditions of Certification

### 24 Conditions

24.1 This Certificate:

- relates only to the product/system that is named and described on the front page
- is granted only to the company, firm or person named on the front page — no other company, firm or person may hold or claim any entitlement to this Certificate
- is valid only within the UK
- has to be read, considered and used as a whole document — it may be misleading and will be incomplete to be selective
- is copyright of the BBA
- is subject to English law.

24.2 References in this Certificate to any Act of Parliament, Regulation made thereunder, Directive or Regulation of the European Union, Statutory Instrument, Code of Practice, British Standard, manufacturers' instructions or similar publication, are references to such publication in the form in which it was current at the date of this Certificate.

24.3 This Certificate will remain valid for an unlimited period provided that the product/system and the manufacture and/or fabrication including all related and relevant processes thereof:

- are maintained at or above the levels which have been assessed and found to be satisfactory by the BBA
- continue to be checked as and when deemed appropriate by the BBA under arrangements that it will determine
- are reviewed by the BBA as and when it considers appropriate.

24.4 In granting this Certificate, the BBA is not responsible for:

- the presence or absence of any patent, intellectual property or similar rights subsisting in the product/system or any other product/system
- the right of the Certificate holder to manufacture, supply, install, maintain or market the product/system
- individual installations of the product or system, including the nature, design, methods and workmanship of or related to the installation
- the actual works in which the product/system is installed, used and maintained, including the nature, design, methods and workmanship of such works.

24.5 Any information relating to the manufacture, supply, installation, use and maintenance of this product/system which is contained or referred to in this Certificate is the minimum required to be met when the product/system is manufactured, supplied, installed, used and maintained. It does not purport in any way to restate the requirements of the Health & Safety at Work etc Act 1974, or of any other statutory, common law or other duty which may exist at the date of this Certificate or in the future; nor is conformity with such information to be taken as satisfying the requirements of the 1974 Act or of any present or future statutory, common law or other duty of care. In granting this Certificate, the BBA does not accept responsibility to any person or body for any loss or damage, including personal injury, arising as a direct or indirect result of the manufacture, supply, installation, use and maintenance of this product/system.



In the opinion of the British Board of Agrément, the Quad-Lock Insulating Concrete Formwork (ICF) System is fit for its intended use provided it is installed, used and maintained as set out in this Certificate. Certificate No 06/4347 is accordingly awarded to Quad-Lock Building Systems.

On behalf of the British Board of Agrément

Date of issue: 13th July 2006

A handwritten signature in black ink, appearing to read 'G. A. Cooper', is written over a white background.

Chief Executive